



## **INMOTION Controls, Inc.**

### **HS receiver**

**K202 Plus Series**

**K404 Plus Series**

**K606 Plus Series**

**K806 Plus Series**

**K808 Plus Series**

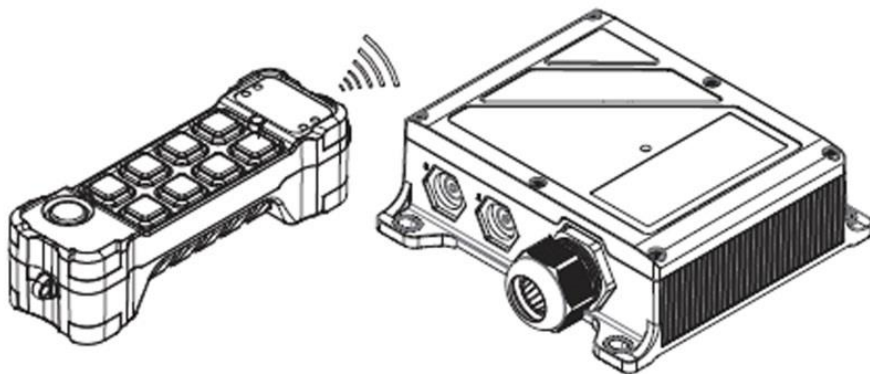

### **Basic Installation Instructions**



**February 2017**

# Contents

## **Contents**

Guarantee, service, repairs and maintenance

## **Chapter1: Customer information**

General Information on Safety

## **Chapter2: General description**

General description

END USER INSTRUCTIONS

## **Chapter 3: Receiver**

INSTRUCTION GUIDE

## **Chapter 4: Troubleshooting**

## **Chapter 5: Accessories**

## **Guarantee, service, repairs and maintenance**

Inmotion Controls, Inc. products are covered by a guarantee/warranty against material, construction and manufacturing defects. During the guarantee/warranty period, Inmotion may replace the product or faulty parts. Work under guarantee/warranty must be carried out by Inmotion Controls, Inc.

### **The following are NOT covered by the guarantee/ warranty:**

- Faults resulting from normal wear and tear
- Parts of a consumable nature such as pushbuttons, relays, fuses etc.
- Products that have been subject to unauthorized modifications
- Faults resulting from incorrect installation and use
- Condensation and water damage

### **Maintenance:**

- Repairs and maintenance must be carried out by qualified personnel.
- Use spare parts from Inmotion Controls, Inc. only.
- Contact your representative if you require service or other assistance.
- Keep the product in a dry, clean place.
- Keep contacts and antennas clean.
- Wipe off dust using a slightly damp, clean cloth.

### **Intended Use:**

The HS and HM Receiving units are intended as the control unit interface of the Radio Remote Control for Hoists, Cranes, Monorail and Material Handling equipment.

### **Operating Methods:**

The receiving unit accepts signals from the Radio Transmitter and processes them to open or close specific relays for Hoist, Trolley, Bridge and various auxiliary functions.

## **Chapter 1: Customer Information**



Thank you for purchasing an Inmotion Controls, Inc. radio remote control.

### **READ ALL INSTRUCTIONS CAREFULLY BEFORE MOUNTING, INSTALLING AND CONFIGURATING THE PRODUCT.**

This manual includes general information concerning the operation of the radio remote control transmitter.

#### **General Information on Safety**

- Persons under the influence of drugs and/or alcohol and/or other medicine that impairs their reaction may not assemble, disassemble, install, put into operation, repair or operate the product.
- All conversions and modifications of an installation/system must conform to the relevant safety requirements. Work on the electrical equipment must be performed only by qualified, authorized personnel and in accordance with the relevant safety requirements.
- In the event of malfunctioning, visible defects or irregularities, the product must be stopped, switched off and the relevant master switches must be switched off.

Symbols and Definitions for Warnings	
	Warning against hazardous situation
	Warning against electrical voltage

#### **FCC Part 15 (FCC ID: RN489896162JK915S)/RX-(RN489896162JK915)**

This equipment has been tested and found to comply with the limits for a Class B digital device, pursuant to part 15 of the FCC Rules. These limits are designed to provide reasonable protection against harmful interference in a residential installation. This equipment generate, uses and can radiate radio frequency energy, and if not installed and used in accordance with the instructions, may cause harmful interference to radio communications. However, there is no guarantee that interference will not occur in a particular installation. If this equipment does cause harmful interference to radio or television reception, which can be determined by turning the equipment off and on, the user is encouraged to try to correct the interference by one or more of the following measures:

- Reorient or relocate the receiving antenna.
- Increase the separation between the equipment and receiver.
- Connect the equipment into an outlet on a circuit different from the to which the receiver is connected.
- Consult the dealer or an experienced Radio/TV technician for help.

Additional information on labeling and user information requirements for Part 15 devices can be found in KDB Publication 784748 available at the FCC Office of Engineering and <http://apps.fcc.gov/oetct/kdb/index.cfm>.

#### **IC Statement (IC: 10821A-89896162902)/RX-(10821A-89896162901)**

This device complies with Industry Canada license-exempt RSS standard(s). Operation is subject to the following two conditions: (1) this device may not cause interference, and (2) this device must accept any interference, including interference that may cause undesired operation of the device.

## Chapter 2: General Description

The K Plus Series transmitter comes in different versions, featuring 2, 4, 6, or 8 pushbuttons. The transmitter also features 2-step pushbuttons. Both steps of each pushbutton can operate different functions like controlling the speed of a movement, step 1: slow, step 2: fast.

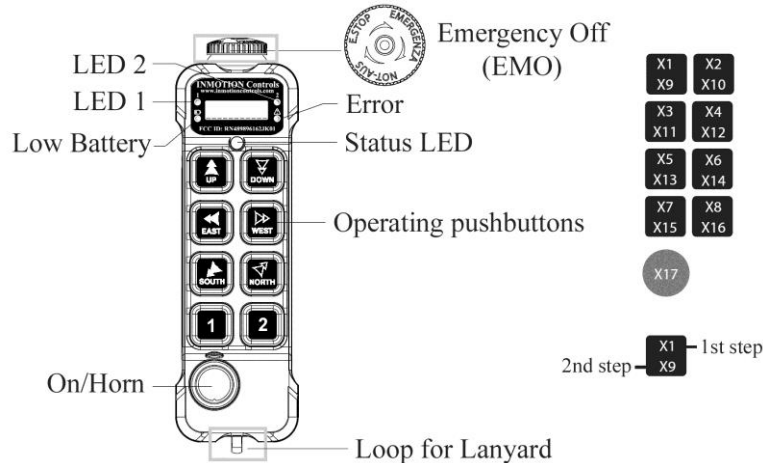

### Start/ Horn switch

The K Plus transmitter has a Start/Horn pushbutton on the left side. The Start/Horn switch has 2 functions:

1. Press to Start.
2. Press for horn while operating.



### Start the transmitter in operating mode

1. Turn to release the Emergency Off button.
2. Press the "START" button.

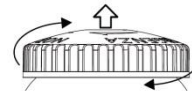

### Turning the transmitter off

Turn the transmitter off by completely pressing the Emergency Off button. The transmitter turns off. All relays deactivate.

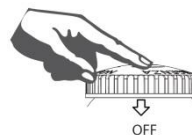

### How to use Qi wireless charging

1. Turn the transmitter off by completely pressing the emergency off button.
2. Place the transmitter on top of the wireless charging pad. You will hear a beep, the battery LED flashes every 1 second. When it is finished charging the battery LED flashes every 5 seconds.
3. Remove the transmitter from the pad.

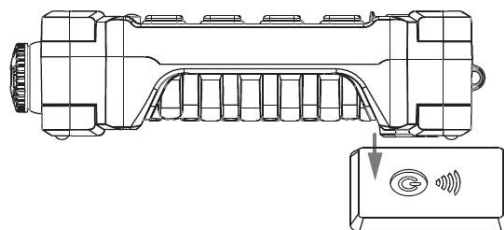

## Chapter 2: General Description

### Changing the batteries:

BATTERY TYPE: AA (HR6) Ni-MH x 2

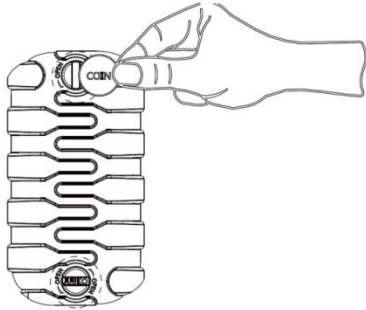

The included batteries are rated for up to 1500 recharge cycles and should not need to be removed for many years of service.

**Warning:** Do not replace batteries with any type other than Ni-MH. Use only 2000mAh batteries.

### Zero-G Safety

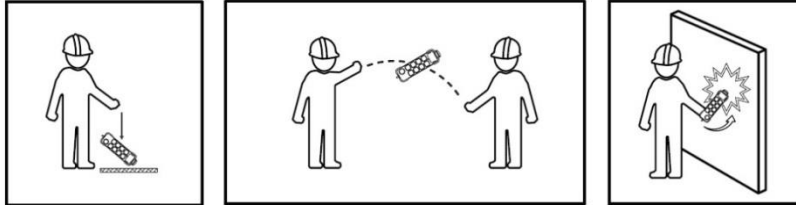

The zero-g safety function can prevent the uncontrolled output of commands in specific emergencies. The G sensor can detect if the transmitter receives a hard impact, dropped or thrown. These features can deactivate either the complete radio system or only the safety-relevant function relays. Alternately, a pre-defined output (e.g. crane horn) can be triggered. Please contact your dealer for special settings.

### Technical Data

Transmitter

Frequency Range	902.5 ~ 927.5MHz
Modulation method	2GFSK
Typical operating range	300 feet
Control system	PLL (Phase Lock Loop)
Antenna impedance	50 ohms
Typical response time for commands	50ms~100ms
Power Supply	AA(HR6) Ni-MH x 2
Antenna	Internal
Average power consumption	38ma@2.5VDC (default setting)
Radio-frequency power	<15dBm (default setting)
Operating and storage temperature	-4°F ~ 131°F / -40°F ~ 149°F
Protection rating	IP65
Dimensions	7.63'' x 2.25'' x 2.00'' (2-8 buttons)
Weight (including battery)	Approx. 11.46 ounces
Housing material	PA6 (30% Glass Filled)

## Chapter 3: Receiver

**WARNING!** The receiver must NOT be opened by any other than a qualified installer. Make sure to turn the electricity off before opening the receiver.

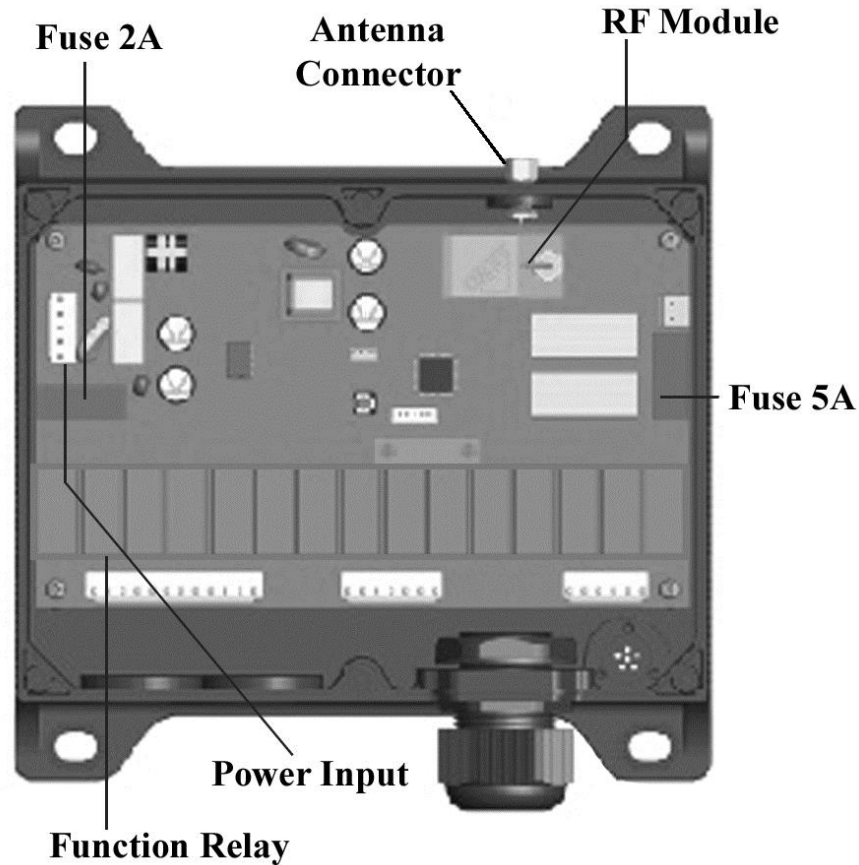

## Technical Data

Frequency	902.5 ~ 927.5MHz
Modulation Method	2GFSK
Sensitivity	-112dBm@baud 1.2K bps
Control System	PLL
Antenna impedance	50 ohms
Typical response time for commands	50mS ~ 100mS
Input Power (AC)/Power Consumption	24 ~ 240V AC, 50/60Hz (8.3 Watts)
Input Power (DC)/Power Consumption	24 ~ 160V DC (128 Watts)
Antenna	External
Standby power	0.97W
Operating and storage temperature	-4°F~131°F/-40°F~149°F
Protection degree	IP 65
Dimensions	7.46" x 7.22" x 2.52"
Weigh	3.95 Lbs.
Housing material	PA6 (30% Glass Filled)

## Chapter 3: Receiver

**WARNING! DO NOT FLUSH MOUNT THE RECEIVING ASSEMBLY. PLEASE MAINTAIN PROPER CLEARANCE AS SHOWN. PLEASE USE THE SUPPLIED MOUNT!**

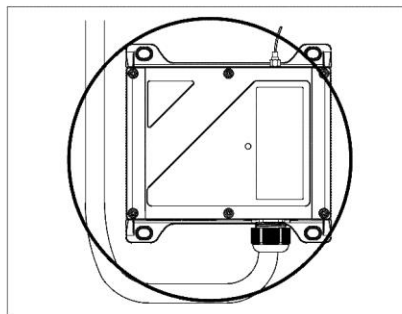
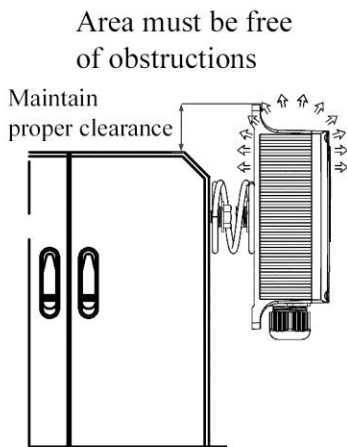

Do not flush mount.  
Use the supplied mounting spring.

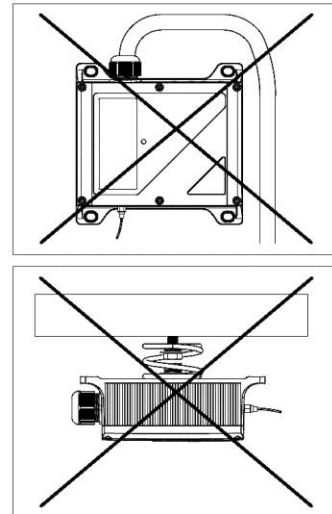

### K202 Plus Wiring Diagram

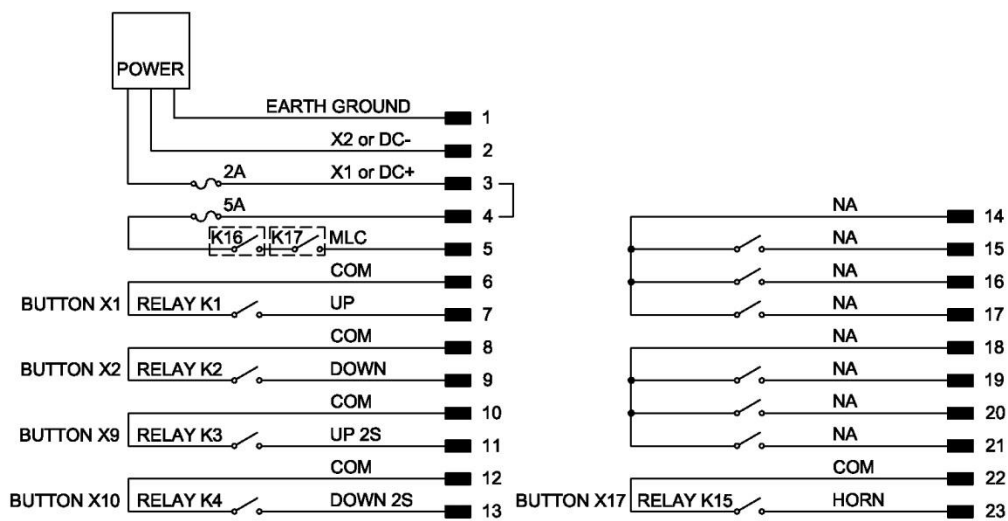

## Chapter 3: Receiver

### K404 Plus Wiring Diagram

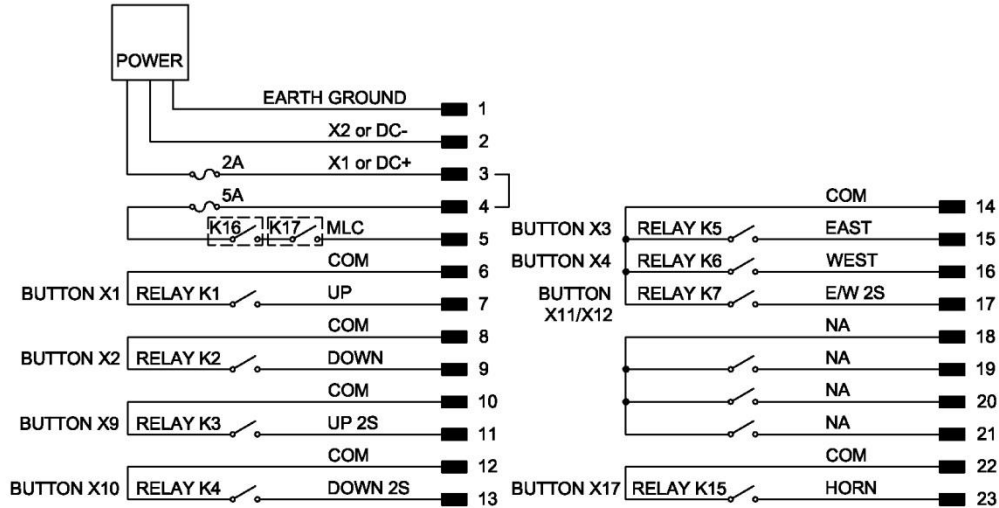

### K606 Plus Wiring Diagram

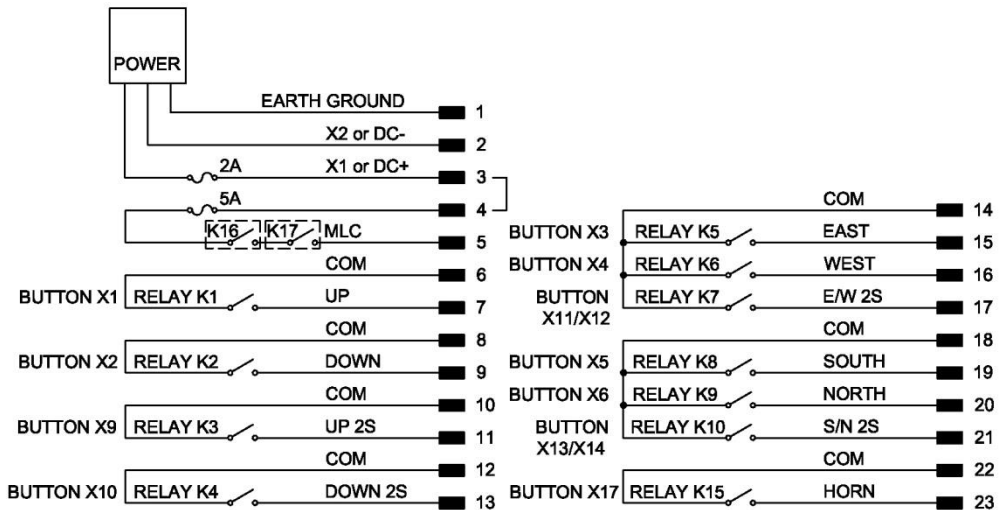



## Chapter 3: Receiver

### K806 Plus Wiring Diagram

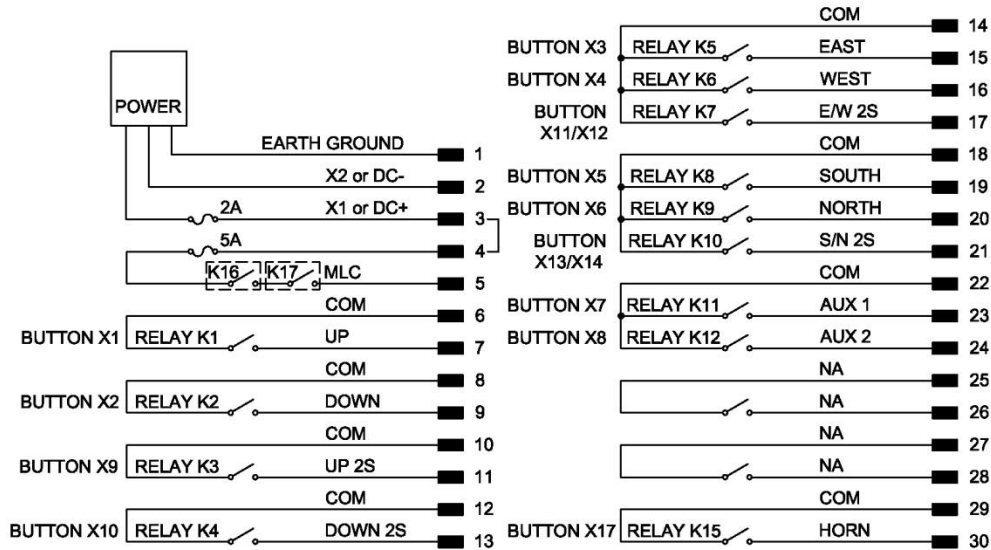

### K808 Plus Wiring Diagram

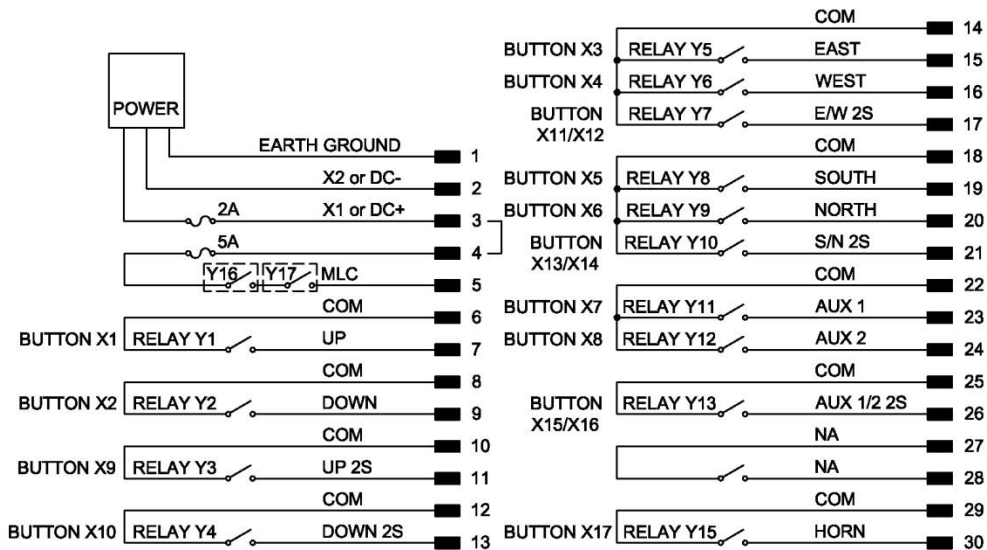

## Chapter 3: Receiver

### Receiver Dimensions (Not to scale)

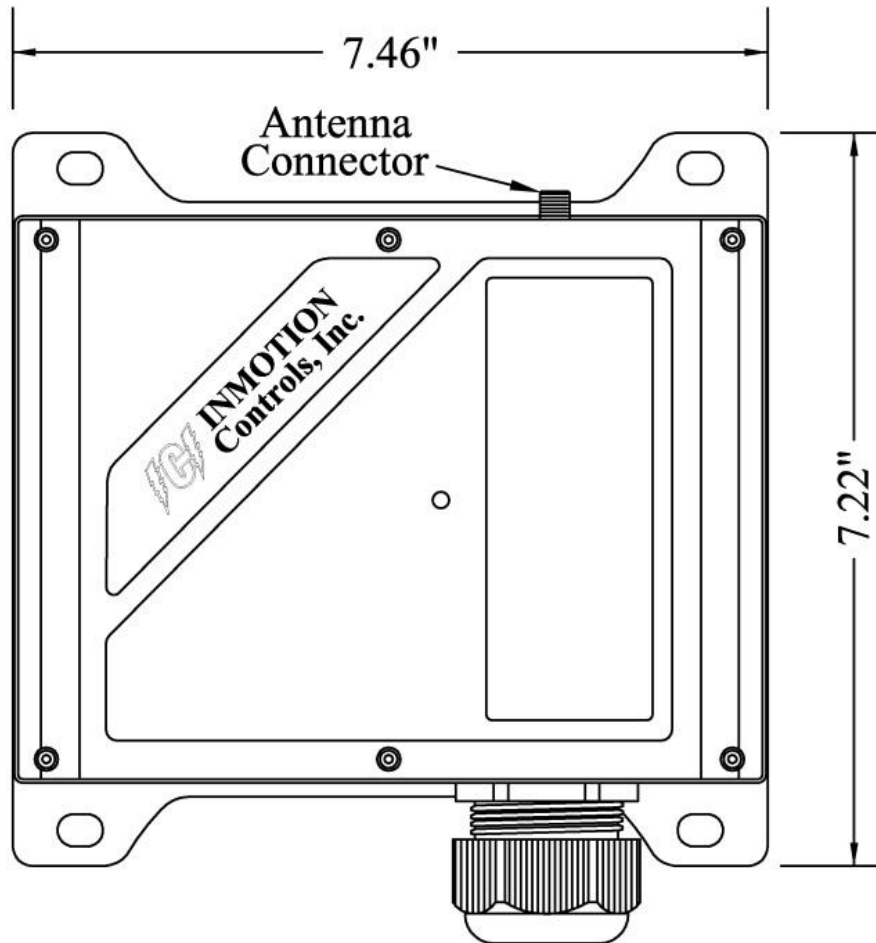

This product is certified to ISO/IEC Guide 17067, Conformity assessment—  
Fundamentals of product certification, System 3, and in accordance with  
**Standard for Safety for electrical equipment for measurement, control, and  
Laboratory use – Part 1: General requirements**

**CAN/CSA C22.2 No. 61010-1-12, 3<sup>rd</sup> Ed. + UDP 1: 2015**

**UL61010-1, 3<sup>rd</sup> Ed. Rev. July 15, 2015**

**Certified Product: Radio Remote Control Receiver**















**Certificate: USTC/16/FAI/00096**

**SGS Reference: 619432/01**

**Contract Number: 710329**



## Chapter 4: Troubleshooting

### Transmitter

LED Signal			Failure Analysis	Solution
 Short  Long				
	Red LED	Green LED	-Corrosion on the Battery Terminals. -Low Battery. -Damaged Batteries.	-Clean the Battery Terminals. -Replace the batteries.
Status				
	●●●●●●			
				
	Red LED	Green LED	-Transmitter is not Communicating with the receiver.	-Check the power supply of the receiver. -Check the fuse in the receiver.
Status		●●●●●●		
				
				
	Red LED	Green LED	-Pushbutton damaged	-Contact dealer.
Status		●●●●●●		
				
	 ●●●			
	Red LED	Green LED	-RF Error.	-Check the antenna and make sure it is not loose. -Contact Dealer.
Status				
				
	 ●●●			
	Red LED	Green LED	-G-Force exceeded.	-Re-Start System.
Status				
				
	●●●●●●			

### Receiver

Should an error occur, the LED of the receiver will indicate the cause.

LED Signal			Failure Analysis	Solution
 Short  Long				
Status	Red LED	Green LED	-RF error	-Check the antenna and make sure it is not loose. -Contact dealer.
	 ●●●			
Status	Red LED	Green LED	-Receiver is not powered.	-Check the fuse. -Check the power supply.

Status	Red LED	Green LED	-The receiver is receiving data.
			

## Chapter 5: Accessories



**Pushbutton Protector**



**Waterproof Case**



**Lanyard**



**INMOTION Controls, Inc.**  
**[www.inmotioncontrols.com](http://www.inmotioncontrols.com)**  
**888-501-2220**